



**HYDROPATH
MARINE**



ELECTRONIC WATER CONDITIONERS

Installation Guide

IMPORTANT

Read these instructions before fitting

HM RANGE
BY HYDROPATH®

Electrical Specifications

Input Voltage 87-240V AC (100 -230 VAC Nominal)

Input Frequency 47-63 Hz (50-60 Hz Nominal)

Material Specifications

Main unit: Anodised Aluminium
End plates: UL V-0 rated polycarbonate

Water and Dust Protection

IP Rating: IP68 IEC 60529 (Transducer unit) IP66 IEC 60529 (Junction box)

Built-in EMI Filter

Meets: FCC 20780 Class B
VDE 0871 Level A

Type Approval DNV Certificate TAP00002RN

Safety

Europe and Worldwide: IEC 60335-1/ EN 60335-1
USA: UL60335-1
Canada: CSA-C22.2 No:60335-1

Overvoltage Category II

Environmental Specifications

Installation category:
Cat II; Altitude: <2000 Mtrs (6562'); Operating Temperature: -20 to + 55° C (-4 to 131°F);
Maximum relative humidity; Max 100% up to 55°C (131° F)

Overload Protection Continuous short or open circuit on all outputs.

Insulation Basic insulation with the metal enclosure bonded to earth.

Servicing

No user repairable parts are fitted. Repair must be undertaken by an authorised repair centre.

Panel Indicators

The unit is fitted with LED indicator lights. The Green LED indicates that the power is on, and the Red indicates that a signal is being transmitted.

This appliance can be used by children aged from 8 years and above and persons with reduced physical, sensory or mental capabilities, or lack of experience and knowledge, if they have been given supervision or instruction concerning the use of the appliance in a safe way and understand the hazards involved. Children shall not play with the appliance. Cleaning and user maintenance shall not be made by children unless they are older than 8 years and supervised.

NRTL Certification and CB Test Certificate

In accordance with the
International (IEC) and
NRTL standards listed
above.



Manufactured to BSEN9002

To be installed in accordance with the
latest IEE wiring instructions.
Fuse rating: 1A.



To be installed in accordance with the
latest IEE wiring instructions.
Fuse rating: 1A.

Electrical Specifications

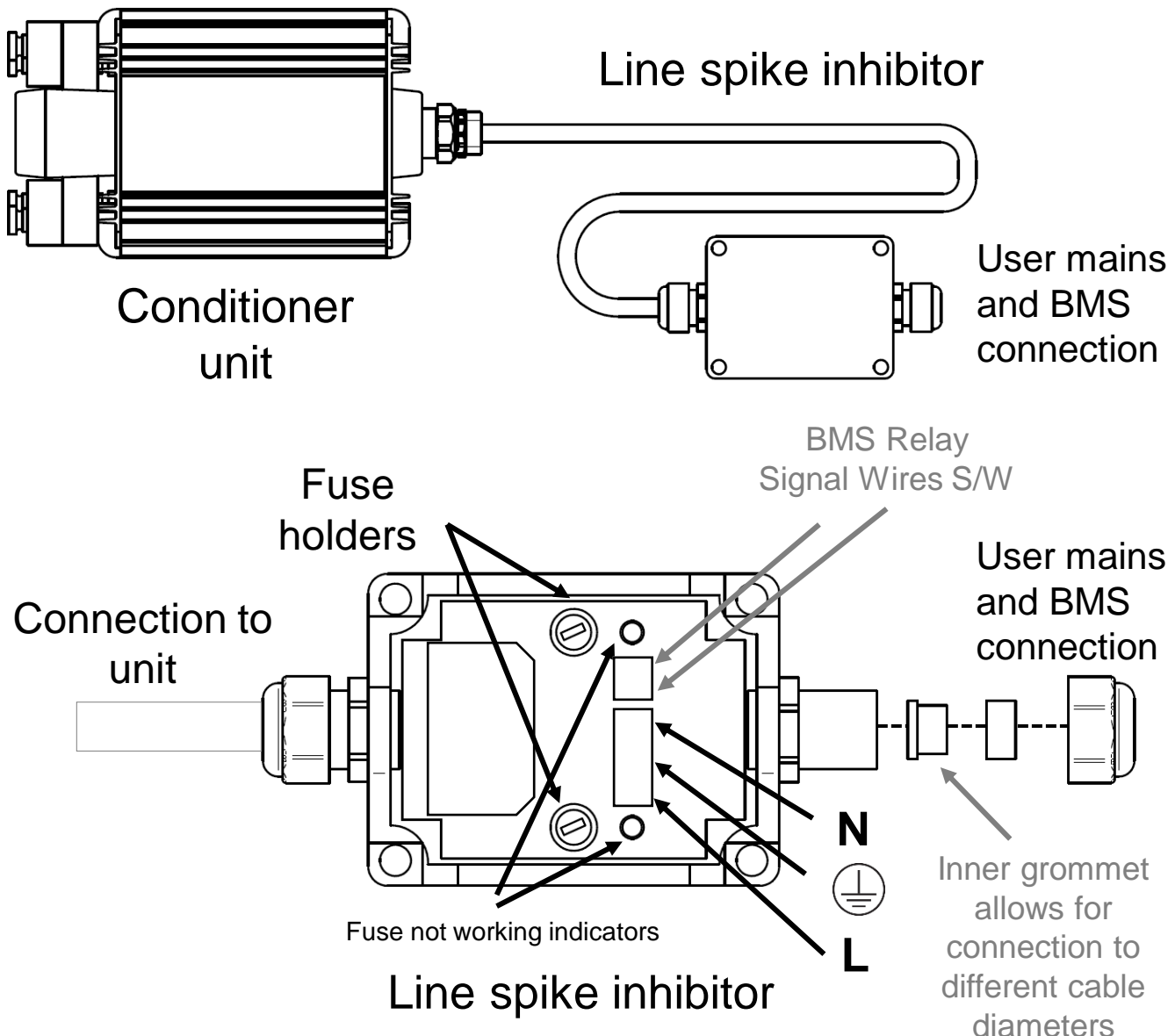

Remote Monitoring Facility

A volt-free normally-open contact closure is provided by the unit connection with a BMS (Business Management System) computer, to monitor that the unit is operating correctly. Connection to the BMS output is made via the junction box. A suitable 5 core approved cable must be used in order to make connection to the mains input and the BMS output.

Electrical Connection

The user must connect the electrical supply to the junction box in accordance with the on-site ruling safety legislation at the time of installation. The power supply must be isolated, for example via an isolating switch or circuit breaker. This is the sole responsibility of the user and the site safety officer must be consulted before installation is undertaken.

This equipment has no user serviceable parts. Return to supplier for servicing. If the equipment is used in a manner not specified by these instructions, the protection provided by the equipment may be impaired

Mechanical Details

The Hydropath Marine range of water conditioners are specifically designed to treat limescale in Marine applications by clustering mineral ions, to enhance filtration by flocculating particles and to reduce biofouling.

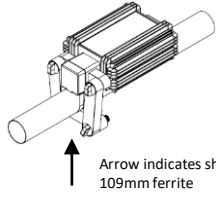
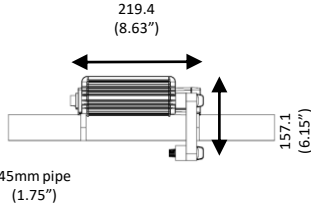
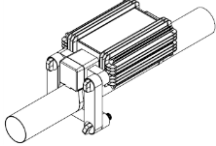
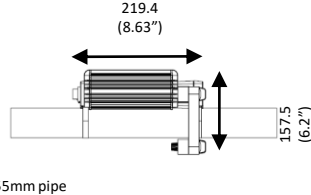
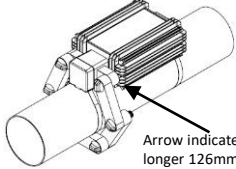
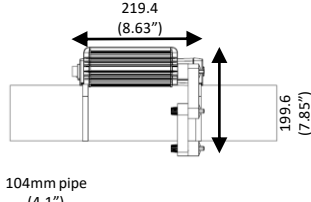
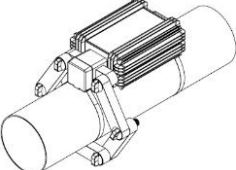
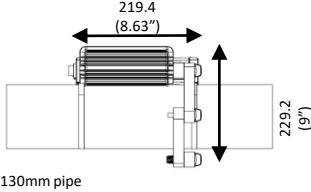
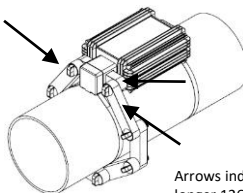
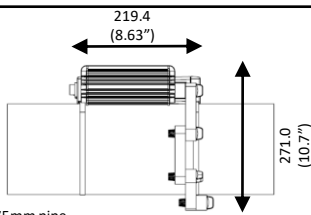
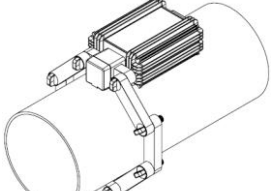
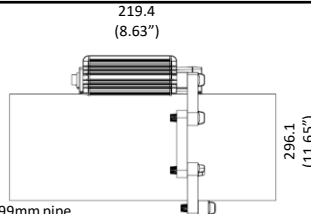
Model	Ferrite Arrangement	Dimensions mm (inches)	Ferrites	Total Weight kg (lbs)
HM45	 Arrow indicates shorter 109mm ferrite	 45mm pipe (1.75")	1 x 109mm (4.25") 3 x 126mm (5.0")	4.1 (8.8)
HM60		 55mm pipe (2.2")	4 x 126mm (5.0")	4.2 (9.2)
HM100	 Arrow indicates longer 126mm ferrite	 104mm pipe (4.1")	5 x 109mm (4.25") 1 x 126mm (5.0")	4.4 (9.7)
HM130		 130mm pipe (5.1")	6 x 126mm (5.0")	4.6 (10.1)
HM150	 Arrows indicate longer 126mm ferrites	 175mm pipe (6.9")	5 x 109mm (4.25") 3 x 126mm (5.0")	5.4 (11.9)
HM190		 199mm pipe (7.8")	8 x 126mm (5.0")	5.8 (12.8)

- All units draw less than 1 amp of current at 120V AC
- Listed weights include: Transducer unit, power supply, ferrites, cables and mounting hardware.

Assembly

DO NOT POWER UP UNIT UNTIL ALL FERRITES SUPPLIED ARE CONNECTED.

POWERING THE UNITS WITHOUT FERRITES WILL INVALIDATE THE WARRANTY

- The unit is supplied with a bracket for ease of mounting to the pipe. The two upper plates should be loosely secured with bolts before installation.
- Smaller units are secured to the pipe using steel clamps and bolts

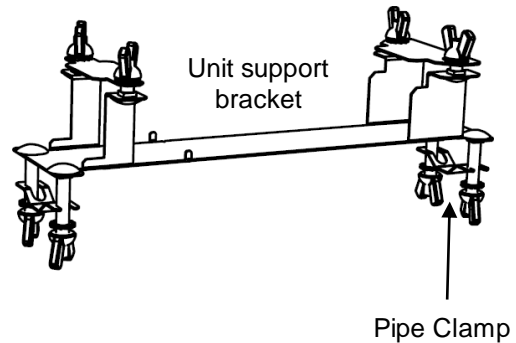

- For larger units, the brackets are supplied with stainless steel banding.
- Pass the two stainless steel bands through the slots in the bracket.

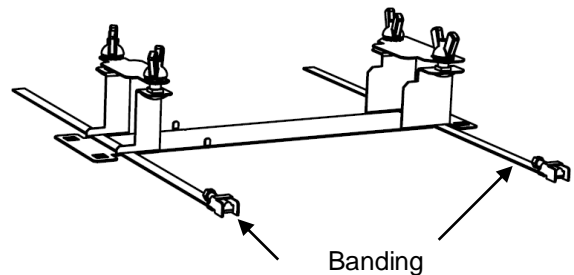

- Place the bracket on the pipe.
- If installing on a vertical pipe, place the bracket with the smaller plate upwards to ease fitting of hexagon nuts.
- Tighten steel hex nuts to secure clamps for smaller units
- Secure straps on larger units by tightening clamps with flathead screwdriver or hex socket driver

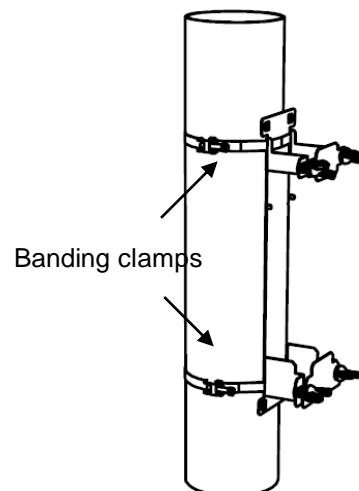

WARNING

The system must be used as specified. Failure to do so will prevent correct operation of device and may impair safety.

Assembly

DO NOT POWER UP UNIT UNTIL ALL FERRITES SUPPLIED ARE CONNECTED.

POWERING THE UNITS WITHOUT FERRITES WILL INVALIDATE THE WARRANTY

- Place the unit on the bracket and hold in place using the swinging plates.
- Secure by tightening the four steel nuts.

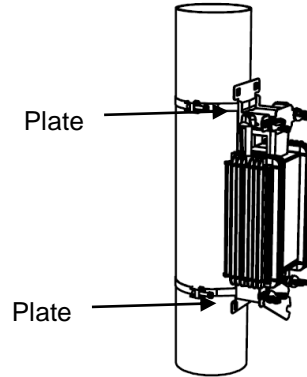

- Insert the two hexagon nuts into the holes in the end plate, next to the ferrite holding cage.
- The transducer unit is supplied with at least one **long** ferrite bar. Insert this through the holding cage until the holes line up with the hexagon nuts.

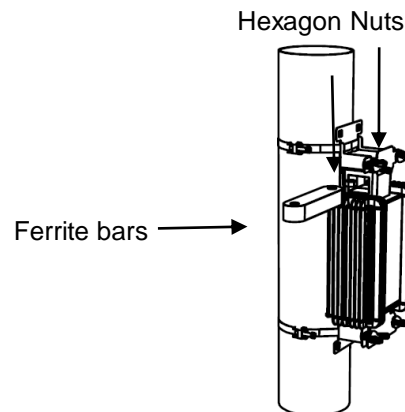

- Take a second ferrite, insert a plastic thumb screw through both ferrite bars and loosely screw into hexagon nut.
- Repeat on opposite side.

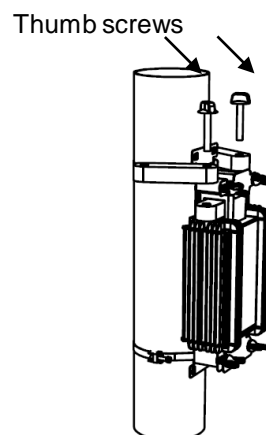

WARNING

The system must be used as specified. Failure to do so will prevent correct operation of device and may impair safety.

Assembly

DO NOT POWER UP UNIT UNTIL ALL FERRITES SUPPLIED ARE CONNECTED.

POWERING THE UNITS WITHOUT FERRITES WILL INVALIDATE THE WARRANTY

- Assemble **all** the other ferrites around the pipe according to the mechanical configuration specified for the unit.
- Loosely secure each ferrite with plastic thumb screws and thumb nuts.

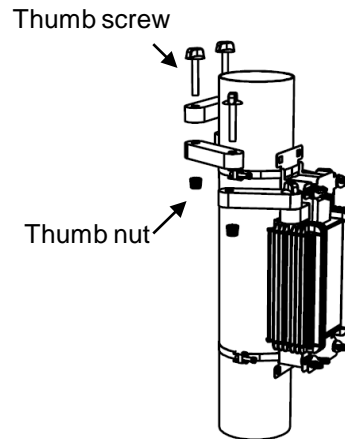

- Once the ferrite ring is complete, tighten all wing nuts until hand tight.
- **Do not over tighten as ferrites are fragile.**

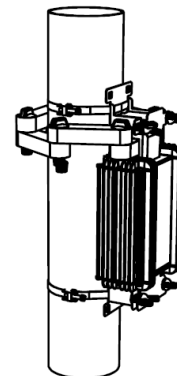

- In accordance with local code and regulations, connect the junction box to the electrical power supply (87V-240V AC).
- Energise the electrical power supply and ensure that the Red and Green LED lights on the unit are glowing brightly.

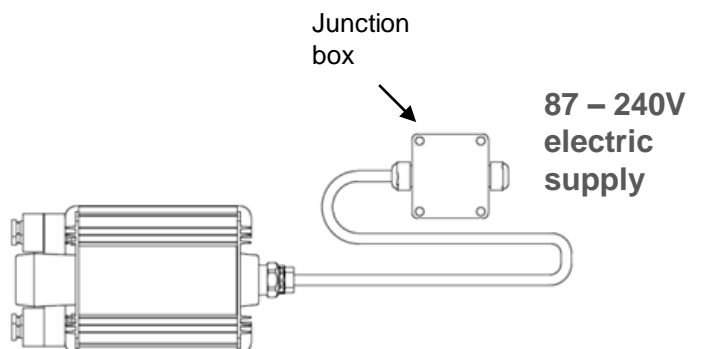

WARNING

The system must be used as specified. Failure to do so will prevent correct operation of device and may impair safety.

Assembly

MOUNTING THE SURGE PROTECTOR

- The surge protector should be mounted in a safe, convenient location.
- To secure the surge protector to a back plate, first drill four 2.2mm pilot holes as shown.

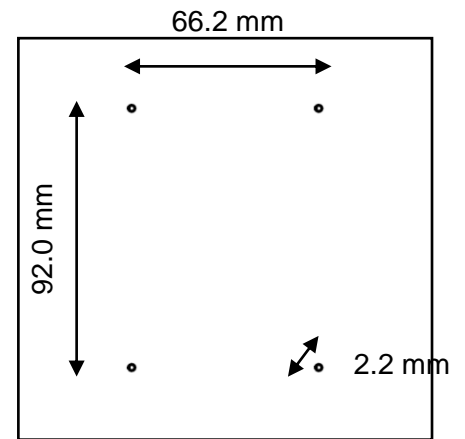

- Remove the surge protector cover by loosening the four screws in the lid.
- Insert the four self-tapping screws into the holes in the surge protector base and into the pilot holes. Tighten until the surge protector is secure.

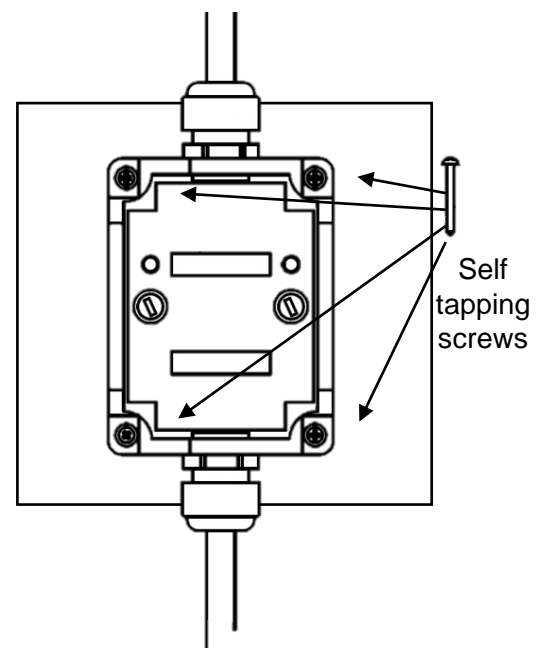

- Once the surge protector base is fixed to the back plate, replace the lid and secure using the four incorporated screws.

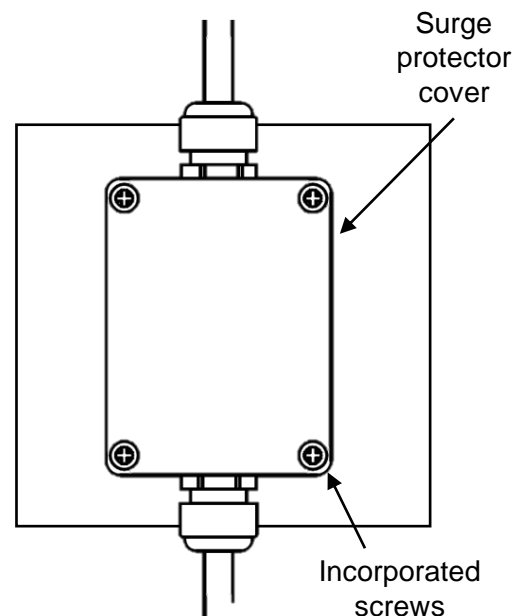

WARNING

The system must be used as specified. Failure to do so will prevent correct operation of device and may impair safety.

Location Criteria

The Hydropath Marine unit can provide a range of benefits, including protection against limescale, treatment of biofouling, and flocculation of particles. The most effective location for the unit depends on the result desired.

- For protection against Limescale due to heating, the unit should be fitted on the cold feed to where the water is heated.
- For protection against limescale, the unit should be fitted after any pumps or filters as these can degrade the conditioning effect.
- To enhance flocculation or kill bacteria, the ideal location is before the pump feeding a filter.

Electrical Loops

The unit operates by creating a potential difference on the pipe on either side of the ferrite ring. An electrical loop is created whenever an electrical connection is made from one side of the ferrite loop to the other, e.g. by metal supports, wiring or pipework. A loop will prevent the unit from operating correctly.

This problem can be solved by moving the unit outside the electrical loop. If this is not possible, the metal support brackets can be electrically insulated. Installing the unit on a section of plastic pipe eliminates the possibility of an electrical loop.

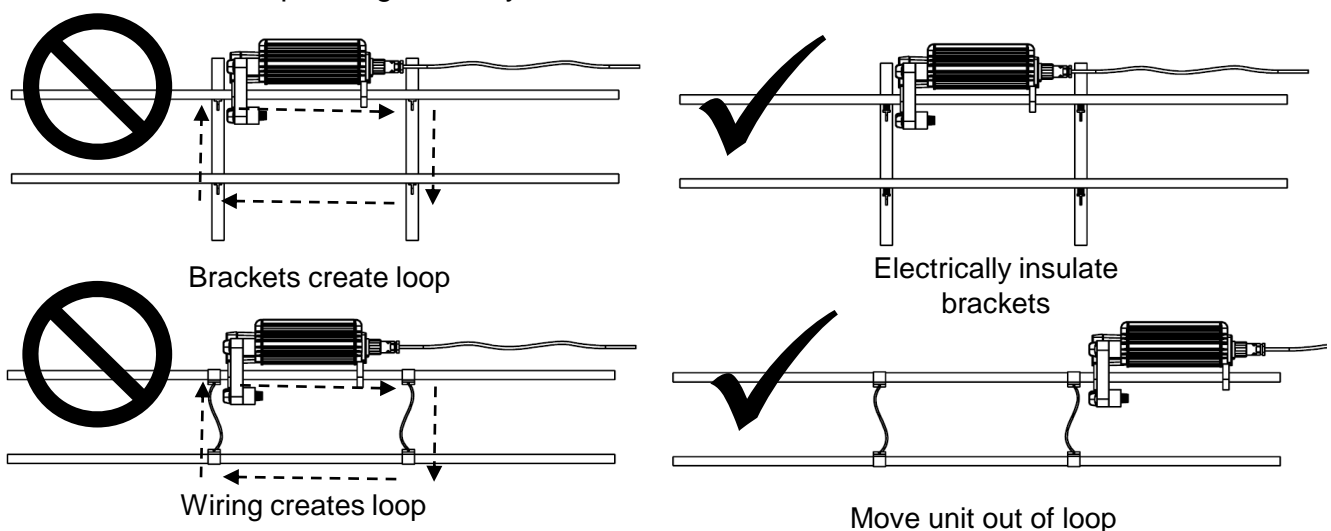

If you are unsure of any details of fitting or installation, please contact your local Hydropath representative for technical support.

Box Contents

Transducer Unit

User Instructions

Threadlock Glue

Stainless Steel Bracket (3 parts)

Self Tapping Screws x 4

Model Supplied		Long ferrites	Short Ferrites	Plastic Hex Nuts	Plastic Thumb Screws	Plastic Thumb Nuts	Stainless Steel Short Bolts, Washers + Wing Nuts	Oeticker Stainless Steel Bands + Clamps	Pipe clamps	Stainless 50mm Bolts, Washers + Wing nuts
HM45		3	1	2	4	2	4	0	2	4
HM60		4	0	2	4	2	4	2	0	0
HM100		1	5	2	6	4	4	2	0	0
HM130		6	0	2	6	4	4	2	0	0
HM150		3	5	2	8	6	4	2	0	0
HM190		8	0	2	8	6	4	2	0	0

Spares: 1x Banding Clamp, 2x Thumb Screws, 2x Thumb Nuts, 2x Hex nuts 2x Self Tapping Screws, 2x Fuses ADH9416

The unit must be registered online to activate the guarantee and warrantee
Register at: www.hydroflow.com

Hydrophath Technology Ltd
 C1 Crossgate Drive
 Queens Drive Industrial Estate
 Nottingham, NG2 1LW
 UK



**HYDROPATH
MARINE**



IMPORTANT

Read these instructions before fitting

HM RANGE
BY HYDROPATH®